

co
ro

0300

INDICE / CONTENTS

<i>Clea</i>	04
<i>Nest</i>	12
<i>Sabal</i>	30
<i>Cocotte</i>	38
<i>Jubeae</i>	42
<i>SG1</i>	52
<i>Livis</i>	64
<i>Fellini</i>	72
<i>Zeta</i>	78
<i>L3</i>	84
<i>Boomy</i>	94
<i>Loop</i>	100
<i>Tasia</i>	104
<i>Joint</i>	110
<i>Shot</i>	116
<i>OBQ-OPQ</i>	122
<i>Doccia / Shower</i>	126
<i>Fioriere/ Flower pots</i>	128
<i>Tavolo Rio/Rio table</i>	130
<i>Tavolo Rab/Rab table</i>	131



CORO, TEMPO DA VIVERE IN LIBERTÀ

Le cose hanno un valore quando servono per vivere. Vivere meglio. La raffinatezza può identificarsi con la semplicità, o la ricchezza con la più essenziale delle forme. Sono maniere diverse di rappresentare l'idea di bellezza. E un bell'oggetto avrà sempre la qualità di arricchirci. A noi importa il tempo che viviamo, al meglio delle possibilità, secondo una personale idea di libertà. Lo vogliamo pieno di energia, vivo di sensazioni, nostro. Dare una forma al piacere di vivere: sotto questo segno cresce il marchio Coro. Lavoriamo per creare oggetti capaci di valorizzare il tempo, oggetti che accompagnano i ritmi diversi della giornata. Ognuno di essi è una nota della nostra maniera di stare al tempo, di inventare la musica del momento. Nel concerto degli elementi che a noi si intonano. Mobili in senso proprio, che stanno bene dovunque, in casa e in giardino. Libera interpretazione del tema internolesterno.

CORO, TIME TO LIVE IN FREEDOM

Things are precious to us when they allow us to live to live better. Sophistication is simplicity, and richness is minimalism. These are different expressions of beauty. And beauty will always enrich our lives. Moments when we live life to the full, according to our own personal concept of freedom, are important to us. We want those moments to be energised, sensual, ours. Coro keeps giving form to the pleasure of living. We create things which enrich time, which accompany the changing moods of every day. Each object sounds a note in our manner of keeping to the rhythm of time, inventing music for each moment. All as part of the concert of elements resounding in tune with us. It is furniture in the real sense, which can go anywhere, inside or outside. A free interpretation of the interior/ exterior theme.

CLEA

design Matteo Nunziati

Quando abbiamo voglia di evadere, di riposo, di liberare la nostra mente, ci basta aprire una finestra e immergerci nel paesaggio dei nostri sogni. Un angolo della nostra casa, il nostro terrazzo o il giardino sono gli spazi dove ricreare i momenti di serenità del nostro tempo libero.

When our main desire is to break out, to take a rest or relieve our mind, sometimes it is enough to open a window and enter into our dreaming landscape. An angle of our home, our terrace or the garden are the places where we create moments of calm of our spare-time.







Poltrona
Armchair



Divano lineare
Linear sofa

NEST

design Stefano Gallizioli

Un divano in versione angolare, che diventa rifugio accogliente come un nido, dove potersi sdraiare. È arricchito da morbidi cuscini per un maggiore comfort. L'elemento caratterizzante è lo schienale in tubolare, la struttura è in acciaio inox satinato, rivestito in PVC rinforzato nylon. Può essere completato da un pouf quadrato, creando un angolo chaise longue o dall'accostamento di due sedute, per una scenografia elegante. Possono essere interpretati in versione monocolore o con abbinamenti in contrasto, attraverso la gamma di tessuti per esterno che li rivestono.

A corner sofa, that looks like a welcoming nest where to lie down in, with some loose cushions placed on to make it even more comfortable. Satin stainless steel frame, covered by reinforced PVC nylon cord on the backrest. The sofa can be combined with a square ottoman to create a chaise longue or two seats, for creating an elegant sitting. Covers and cushions are available in a single colour or in different colours with a special dedicated fabric for outdoor use.





Divano lineare 270
Linear sofa 270







Divano sx / Chaise longue dx
Sofa sx / Chaise longue dx



Divano Lineare - Elemento centrale 90 - Tavolino rettangolare
 Linear sofa - Central component 90 - Rectangular low table



Poltrona
Armchair



Divano circolare 90
Circular sofa 90



Chaise longue





SABAL

design Matteo Nunziati

Il rapporto oggetto - ambiente è diventato sempre più importante per determinare la qualità di quello che "disegniamo" e "progettiamo": usare il tratto leggero permette una creativa fusione di gusto ed equilibrio.
Non vogliamo semplicemente produrre un elemento, vogliamo vivere con esso.

The relationship between an object and its surroundings has become increasingly important in determining the quality of what we "design" and "plan": using a light touch ensures a creative mix of good taste and balance.
We do not simply want to produce an item of furniture, we want to live with it.









Divano lineare 240 dx-sx tavolino cuscino laterale
Linear sofa 240 dx-sx side cushion and table

COCOTTE

design Ilaria Marelli

Morbida e divertente Cocotte, con un rivestimento bicolore e bottoni che ne accentuano l'aspetto giocoso, si caratterizza per la sua flessibilità modulare e per la cura dei dettagli sartoriali.

The soft and funny Cocotte, has a two-tone covering with buttons that emphasize the playful look. Cocotte stands out for its modular flexibility and tailored details.





TINEL BE



Poltrona-pouf
Armchair-pouf

JUBEAE

design CDC

Un oggetto è un mezzo per personalizzare ancora di più la filosofia della vita, la ricerca del materiale e delle forme per identificare sempre più il proprio obiettivo tra ispirazione minimalista e creativa emozionalità per proseguire il dialogo, molto trend tra outdoor indoor.

An object which represents the means to add a further personal perspective of the philosophy of life, the research into materials and shapes, to guide towards an ever - increasing focus on its own objective of formally linking together minimalist and creative sensitivity, in order to find the consensus between those who wish to explore further the highly modern trend for a dialogue between indoor and outdoor spaces.





Sedia
Chair





Poltrona
Armchair



SG 1

design Stefano Gallizioli

La collezione prevede sedie con e senza braccioli, poltrona, divanetto, poltrona a dondolo, sgabelli, chaise longue, amaca e lettino caratterizzate dalla struttura in acciaio inox satinato. Seduta e schienale in tondino di PVC rinforzato nylon, cordino acrilico o in doghe di poliuretano rigido in diversi colori.

The collection offers chairs with or without armrests, armchairs, sofas, rocking armchairs, stools, chaises longues, hammock and sun loungers, characterised by their satin stainless steel frame. Seats and back rests come either in reinforced PVC nylon cord or stiff polyurethane slats in different colours.



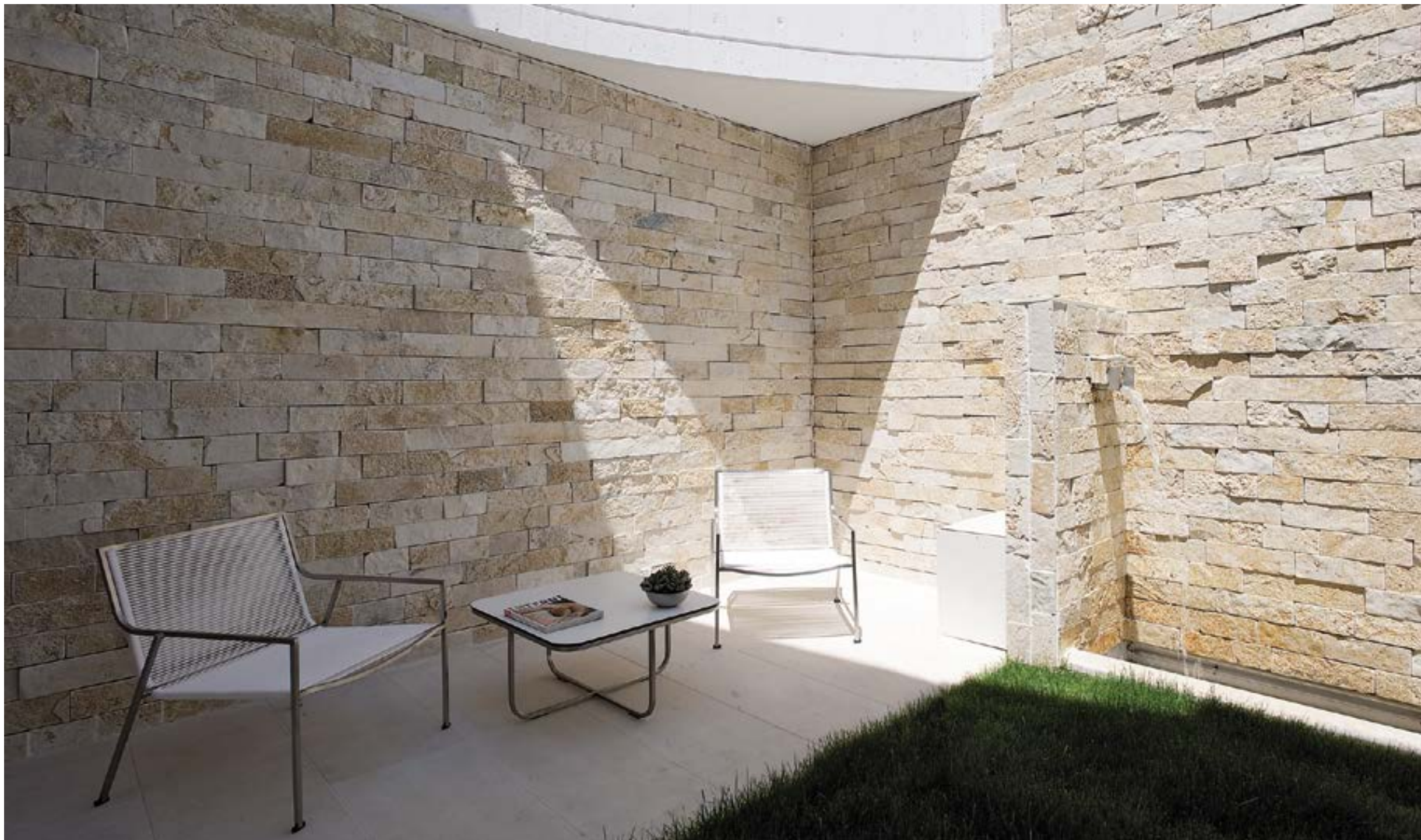

P/TQb





L/P/S/SB





LIVIS

design Matteo Nunziati

Quando si vuole vivere con intensità lo spazio esterno, si associa immediatamente l'idea di confort e funzionalità.

I tratti degli oggetti assumono qualità espressive ed intense, adatte a trasmettere un feeling tra l'uomo e il cosmo che lo circonda al fine di mixare le due realtà in modo trasversale.

When one wants to experience outdoor spaces to the fullest, the idea of comfort is associated with functionality. The features of the objects assume expressive and intense qualities, useful to create a feeling between the man and the surrounding cosmos. In this way, these two realities will blend together entirely.

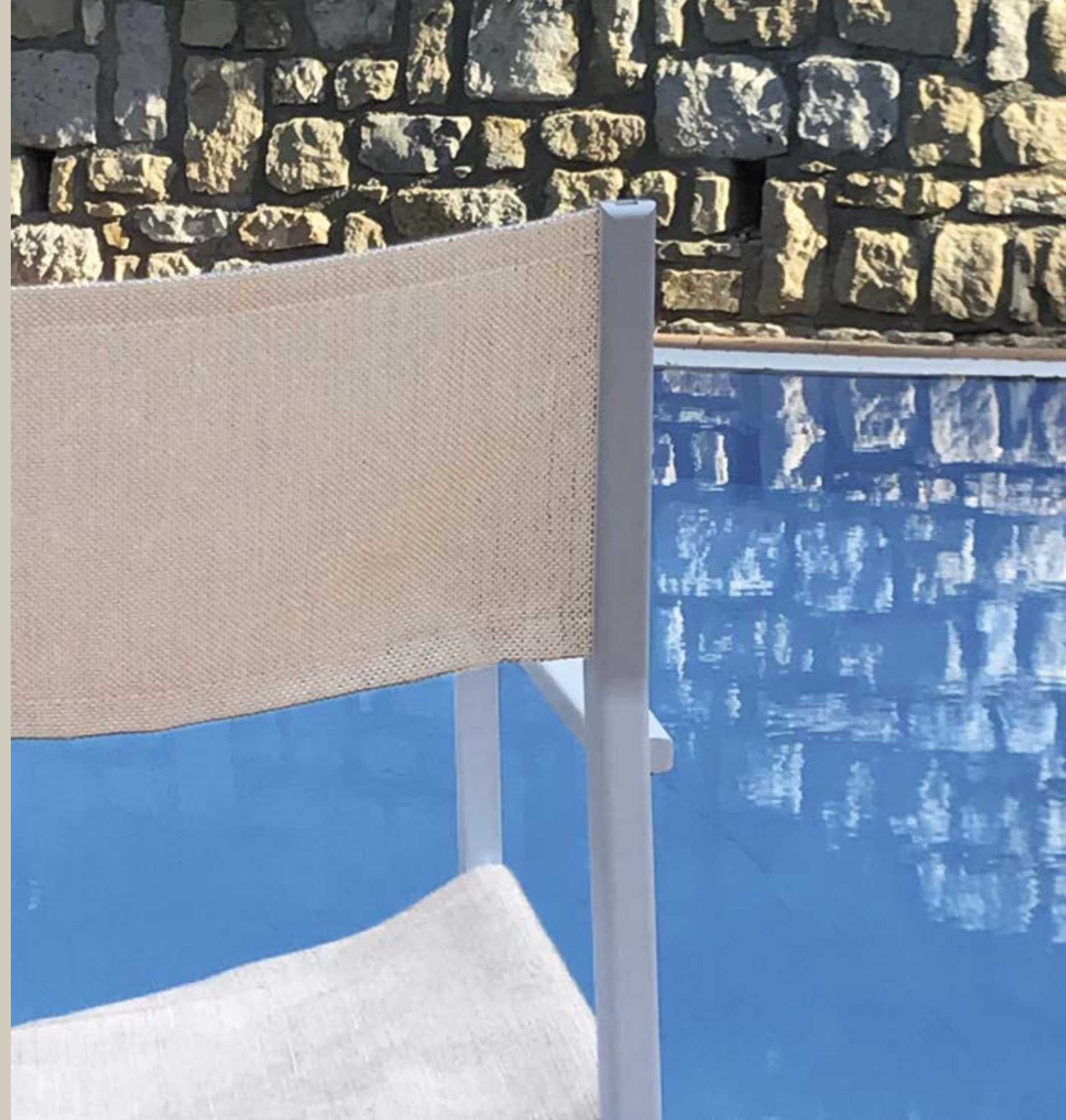





Sedia
Chair



FELLINI

design Stefano Gallizioli

Interni ed esterni, tra questi ambiti si svolge la trama di un film, o il succedersi dei tempi, in un alternarsi di sequenze e di situazioni. Ciascuno ne dà la più personale interpretazione. Noi pensiamo che la scena mobile della vita, in casa o all'aperto, chiedi una regia dinamica, sensibile ed al tempo stesso rilassata. Per questo abbiamo dato il nome di Fellini a una linea che ha come motivo portante la rielaborazione in acciaio inox della tradizionale sedia da regista per ampliarsi in una collezione di sedute. Novità del disegno, tecnica costruttiva e varietà dei materiali tradotte in comfort e versatilità. Di valori concreti è fatta "La dolce vita".

Indoors and outdoors, the plot of a movie, or the passage of the time, takes place between these two scenarios alternating scenes and situations. Each of us gives his own personal interpretation. We believe that the mobile scene of life, whether inside or outside, requires a dynamic, sensitive and, at the same time, easy-going direction. This is the reason we have given the name of Fellini to a collection which has as its main theme the revamping of the traditional director's chair in stainless steel and which develops the seating collection further. Innovations in design, construction technique and variety of materials translate into comfort and versatility. From solid values comes "La dolce vita".







Sedia
Chair

ZETA

design James Irvine

Stare insieme è un piacere che si traduce nel piacere degli altri. La ricetta per rendere conviviale un momento di incontro non può che essere personale. Di certo, nel gioco degli elementi che si combinano per creare un ambiente informale, gli oggetti hanno un ruolo essenziale: presenze opportune e discrete, supporti gradevoli e adattabili al contesto. Così abbiamo voluto ZETA, la linea che realizza un criterio assolutamente originale di mobile pieghevole e riponibile. Sedie e tavoli che si installano e si rimettono a posto con sorprendente facilità. Perché ordine e disordine sono composti dagli stessi elementi. Diversamente disposti.

Togetherness is a pleasure that is found in the pleasure of others. The art of making a shared moment cherishable is nothing if not highly personal. One thing is sure: in the masterful combination of elements that create an informal ambiance, objects are paramount: they need to be appropriate, discreet and pleasant props that adapt to the context. This is why we wanted to make ZETA, a line that embodies an absolutely original idea for fold-and-stow furniture. Chairs and tables that are amazingly easy to set up and put away. You see, order and disorder are made up of the same elements. Just differently arranged.

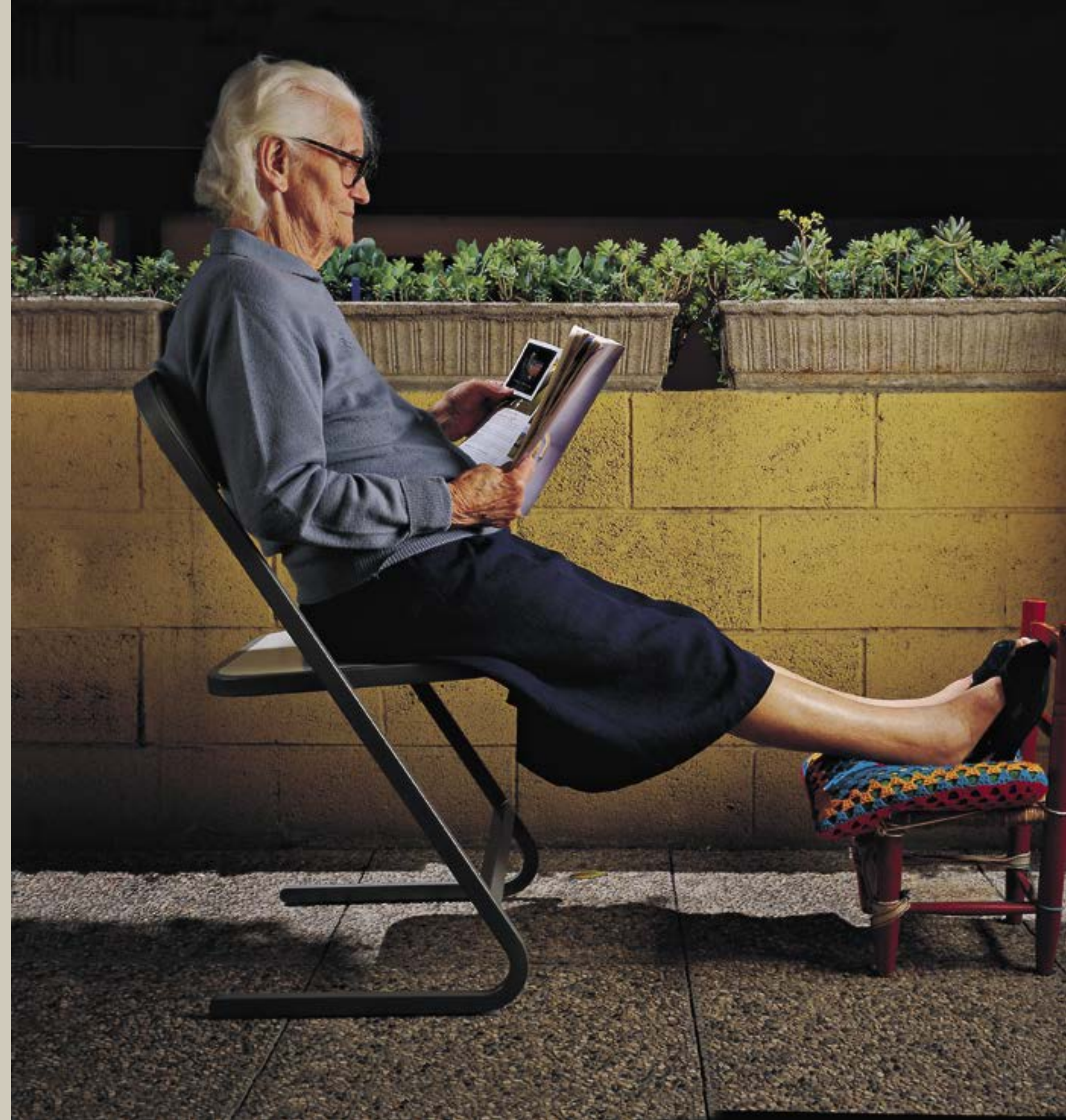



Sedia pieghevole impilabile
Stackable folding chair





Tavolo quadrato-rotondo
Square-round table



L3

design Sergio Brioschi

Comfort e benessere per migliorare il tempo da dedicare alla vita privata. Design minimal e leggero gli aggettivi per questo prodotto caratterizzato dalle linee arrotondate, per rilassarsi e giocare con la fantasia leggendo piacevolmente un libro. L'emozione sensoriale nei colori, nei tessuti e nelle forme, è un gioco di oggetti che si armonizzano per unire sempre più indissolubilmente l'esterno con l'interno e viceversa, il desiderio di sostare, di riposare, e stare con gli amici, la nostra vita di relax.

Comfort and well-being to improve your free time. Minimal and light design these are the qualities of this product distinguished by its rounded lines, for relaxing and playing with fantasy reading a book. The sensory emotions of the colours, textiles and forms is an interplay of objects that harmonise to combine ever more inextricably outdoors with indoors (and vice versa) the desire to stop, rest, spend time with friends and enjoy relaxation.







Lettino impilabile
Stackable sun lounger





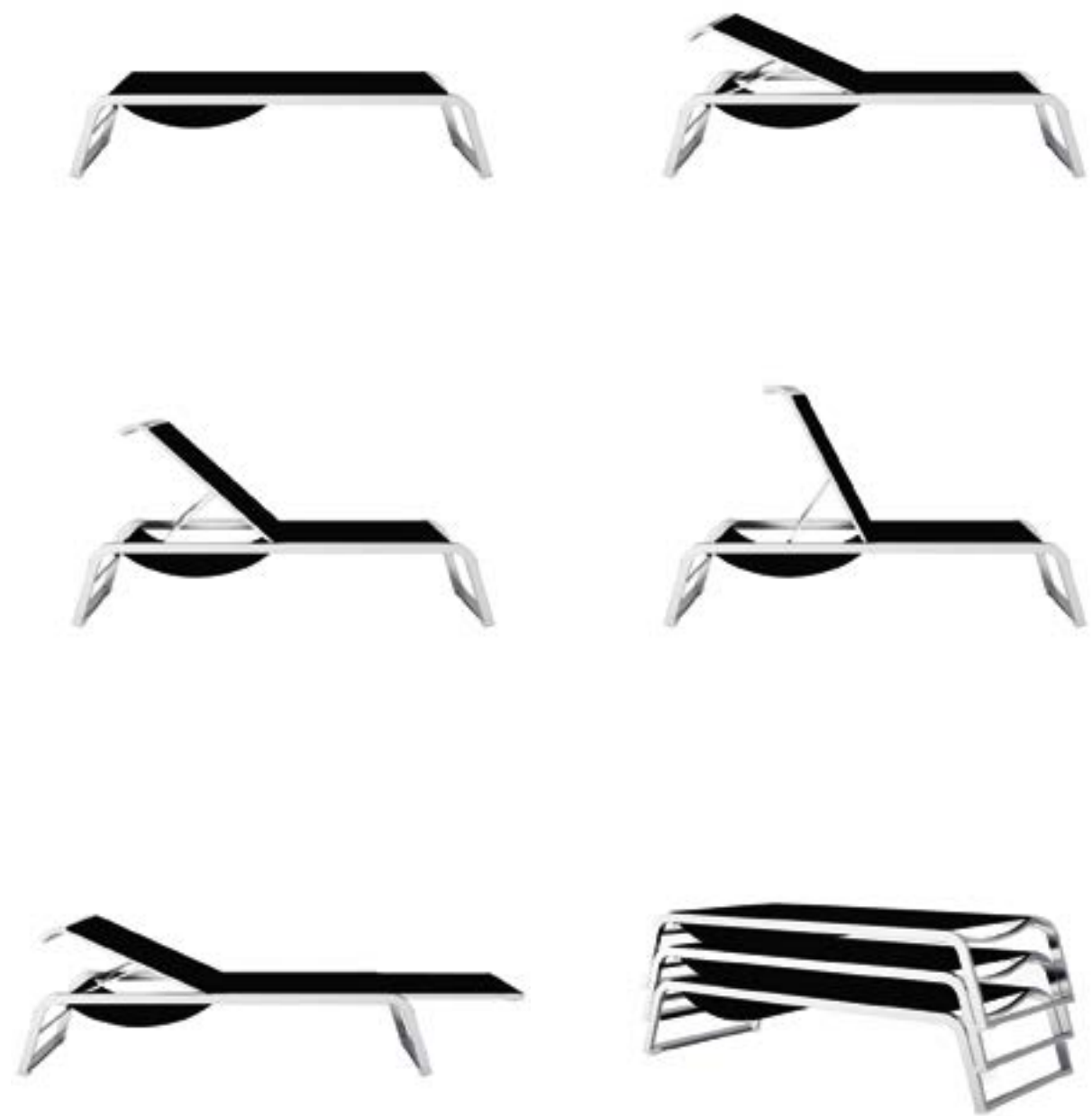

BOOMY

design Matteo Nunziati

Boomy esprime la ricercatezza nel trovare forme, texture e colori che coniugano la contemporaneità e l'artigianalità creando icone attuali che sono il connubio del bello e della qualità. L'incrocio, le linee, il dettaglio, il tratto, tutto permette di creare un elemento che narra di sé e di chi lo ha immaginato.

Boomy expresses the sophisticated pursuit of shapes, textures and colors that combine contemporary life with fine craftsmanship, to create trendy icons that represent the marriage of beauty and quality. The weave pattern, the lines, the detail, the features: everything makes it possible to create an item that illustrates its concept and that of its designer.





Sdraio
Deck chair



LOOP

design Gala Wright

Confortevole, moderna, funzionale Loop ci aiuta a vivere con leggerezza la nostra voglia di riposo e interpreta in modo essenziale, con le sue curve, il nostro desiderio di evasione.

Comfortable, modern and practical Loop helps us live our desire to rest in the lightest way possible. Through its shape, Loop reflects our desire to escape from reality.





TASIA

design Matteo Nunziati

Nel lineare processo creativo espresso dagli schizzi che poi daranno vita all'oggetto, si innesta la componente concreta della sua realizzazione, privilegiando i dettagli, anche quelli più nascosti, ottenendo così un prodotto che si distingue per la sua forma e la particolarità tattile della sua superficie.

During the linear creative process, expressed by the sketches that give life to the object, the concrete component of its realization takes place. The details, even the most hidden ones, are privileged in order to create a new product, whose shape and particular tactile surface make it stand out.







JOINT

design CDC

Le forme del design dell'arredo outdoor diventano veri e propri codici espressivi del desiderio umano di vivere la nostra dimensione del riposo e della vita all'aria aperta. Il tavolo Joint si inventa e si crea in molteplici dimensioni, modulandosi secondo le varie necessità. La struttura in acciaio si unisce con un raccordo a scomparsa che trasforma la nostra cena a due in una festosa tavolata.

The shapes of the outdoor furniture design become real expressive codes of the human desire to live the dimension of relax and life in open air. The Joint Table is designed to meet every needs by reinventing and recreating itself through multiple dimensions. The stainless steel structure is joined by a special hidden juncture, which transforms our dinner for two into a joyful banquet table.







Tavoli con gamba centrale di unione
Tables with jointed central leg

SHOT

design Stefano Gallizioli

Un tavolo diventa realtà attraverso un lavoro di progettazione, di definizione dell'immagine e di trasformazione industriale. Un oggetto che accompagna i diversi momenti della giornata, aggiungendo una nota di personalità, di grande libertà e di piacere, che sposa alla funzionalità un'eleganza sempre raffinata.

A table becomes reality through design, image definition and industrial processing. An object for various moments of the day, adding a personal and highly pleasing note, totally free of restrictions, combining practicality with unerringly sophisticated elegance.





Tavolo rettangolare in piano stratificato
Rectangular table in high thickness laminate



Tavolo quadrato alto in doghe di poliuretano rigido
Square dinner table in stiff polyurethane slats



OBQ OPQ

design Stefano Gallizioli

Ombrellone semplice e funzionale, un oggetto che completa la nostra "stanza" all'aperto creando leggerezza agli elementi con cui vive. Per donare atmosfera ai nostri momenti di relax.

Practical and easy sunshade, an object that makes our "outdoor room" complete by adding lightness to the surrounding elements and increasing atmosphere to our relaxing moments.





DOCCIA/SHOWER

design Danny Venlet

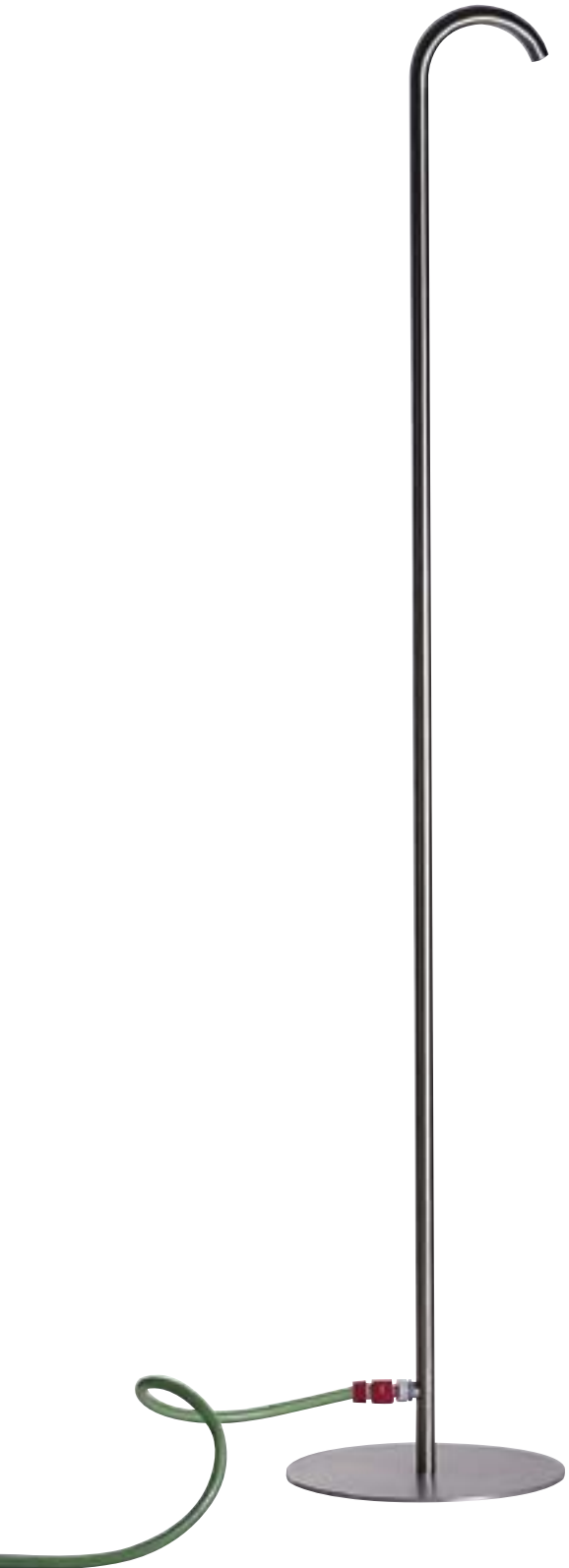

FIORIERE

design Stefano Gallizioli



TAVOLO RIO

design Ilaria Marelli



TAVOLO RAB

design CDC







DISEGNI TECNICI / TECHNICAL DRAWINGS

Struttura in acciaio verniciato /
Powder coated steel frame



Divano Lineare / Linear Sofa

Cuscino seduta e schienale in imbottitura in dryfeel, rivestimento sfoderabile in tessuto outdoor in vari colori.

Seat and back cushion padding in dryfeel polyurethane, removable outdoor fabric cover, available in different colours.

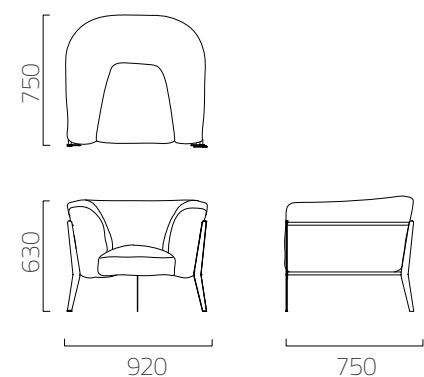
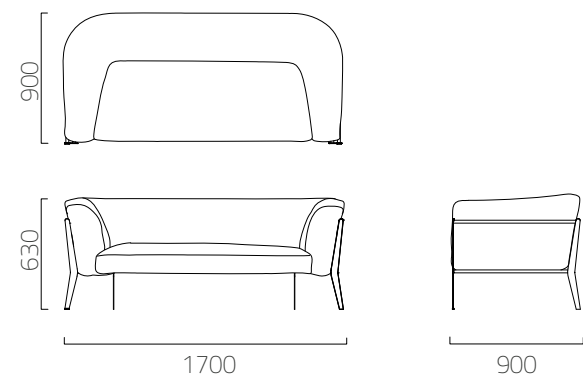

Poltrona / Armchair

Cuscino seduta e schienale in imbottitura in dryfeel, rivestimento sfoderabile in tessuto outdoor in vari colori.

Seat and back cushion padding in dryfeel polyurethane, removable outdoor fabric cover, available in different colours.

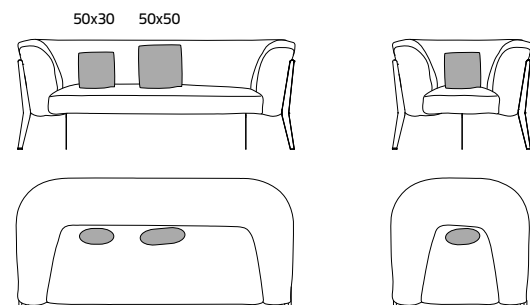

**Cuscino con imbottitura in dryfeel. Rivestimento sfoderabile in tessuto Garden
Dryfeel pad cushion. Cover in Garden fabric**

Cuscino schienale cm 50x30, 50x50

Back cushion cm 50x30, 50x50

Struttura in acciaio inox satinato o verniciato/
Brushed stainless steel or powder coated steel frame



Divano circolare / Circular sofa

Schienale intrecciato tondino PVC, cordino acrilico.
Cuscino seduta con imbottitura in dryfeel.
Rivestimento sfoderabile in tessuto Garden.
Copertura in tessuto Tessil.

PVC, acrylic cord woven backrest.
Cushion padding in dryfeel polyurethane.
Removable Garden fabric cover.
Tessil fabric cover.

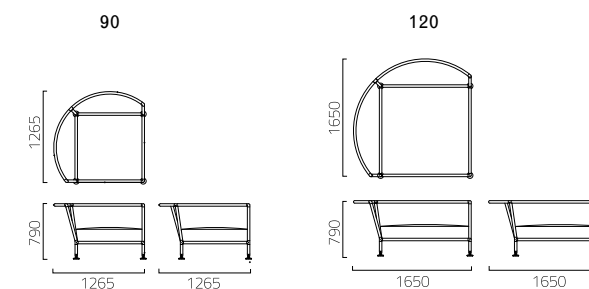

Divano lineare / Linear sofa

Schienale intrecciato tondino PVC, cordino acrilico.
Cuscino seduta con imbottitura in dryfeel.
Rivestimento sfoderabile in tessuto Garden.
Copertura in tessuto Tessil.

PVC, acrylic cord woven backrest.
Cushion padding in dryfeel polyurethane.
Removable Garden fabric cover.
Tessil fabric cover.

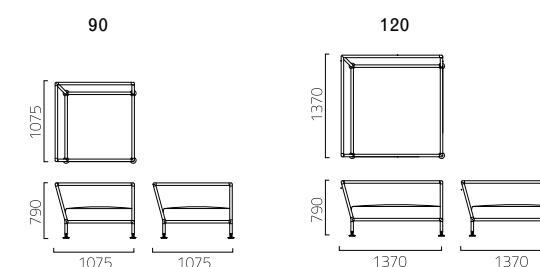

Divano dx-sx / Sofa dx-sx

Schienale intrecciato tondino PVC, cordino acrilico.
Cuscino seduta con imbottitura in dryfeel.
Rivestimento sfoderabile in tessuto Garden.
Copertura in tessuto Tessil.

PVC, acrylic cord woven backrest.
Cushion padding in dryfeel polyurethane.
Removable Garden fabric cover.
Tessil fabric cover.

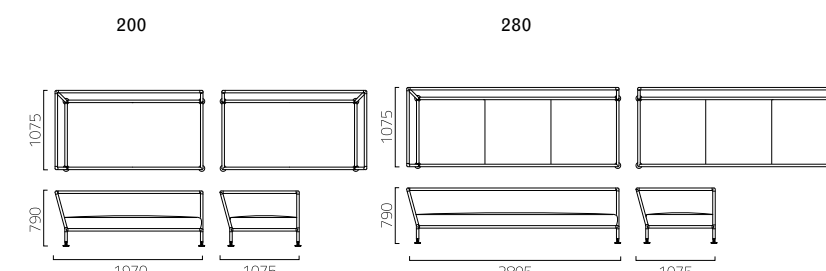

Elemento centrale / Central component

Schienale intrecciato tondino PVC, cordino acrilico.
Cuscino seduta con imbottitura in dryfeel.
Rivestimento sfoderabile in tessuto Garden.
Copertura in tessuto Tessil.

PVC, acrylic cord woven backrest.
Cushion padding in dryfeel polyurethane.
Removable Garden fabric cover.
Tessil fabric cover.

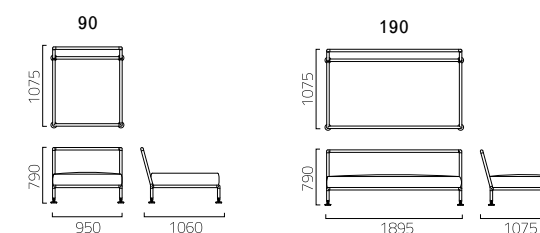

Chaise longue



Schienale intrecciato tondino PVC,
cordino acrilico.
Cuscino seduta con imbottitura in dryfeel.
Rivestimento sfoderabile in tessuto Garden.
Copertura in tessuto Tessil.

PVC, acrylic cord woven backrest.
Cushion padding in dryfeel polyurethane.
Removable Garden fabric cover.
Tessil fabric cover.

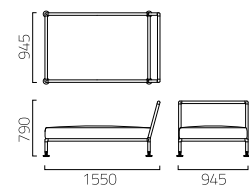

Chaise longue dx - sx



Schienale intrecciato tondino PVC,
cordino acrilico.
Cuscino seduta con imbottitura in dryfeel.
Rivestimento sfoderabile in tessuto Garden.
Copertura in tessuto Tessil.

PVC, acrylic cord woven backrest.
Cushion padding in dryfeel polyurethane.
Removable Garden fabric cover.
Tessil fabric cover.

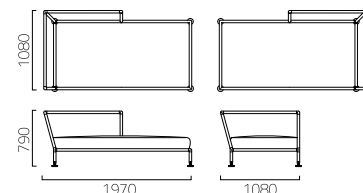

Divano Lineare / Linear sofa

Schienale intrecciato tondino PVC,
cordino acrilico.
Cuscino seduta con imbottitura in dryfeel.
Rivestimento sfoderabile in tessuto Garden.
Copertura in tessuto Tessil.

PVC, acrylic cord woven backrest.
Cushion padding in dryfeel polyurethane.
Removable Garden fabric cover.
Tessil fabric cover.

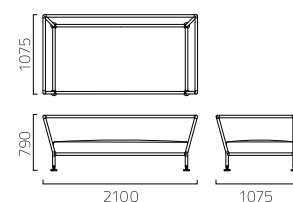

Divano Lineare / Linear sofa

Schienale intrecciato tondino PVC,
cordino acrilico.
Cuscino seduta con imbottitura in dryfeel.
Rivestimento sfoderabile in tessuto Garden.
Copertura in tessuto Tessil.

PVC, acrylic cord woven backrest.
Cushion padding in dryfeel polyurethane.
Removable Garden fabric cover.
Tessil fabric cover.

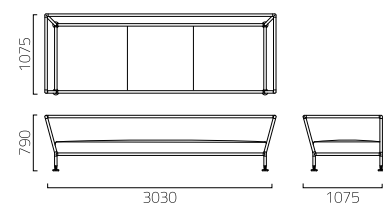

Pouf / Ottoman



Cuscino seduta con imbottitura in dryfeel.
Rivestimento sfoderabile in tessuto Garden.
Copertura in tessuto Tessil.

Cushion padding in dryfeel polyurethane.
Removable Garden fabric cover.
Tessil fabric cover.

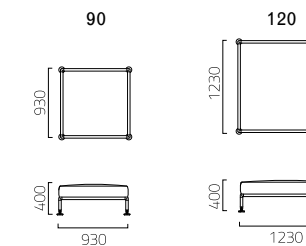

Poltrona / Armchair



Schienale intrecciato tondino PVC,
cordino acrilico.
Cuscino seduta con imbottitura in dryfeel.
Rivestimento sfoderabile in tessuto Garden.
Copertura in tessuto Tessil.

PVC, acrylic cord woven backrest.
Cushion padding in dryfeel polyurethane.
Removable Garden fabric cover.
Tessil fabric cover.



Cuscino schienale divano / Back cushion

Imbottitura in poliuretano dryfeel.
Rivestimento sfoderabile in tessuto Garden.

Dryfeel polyurethane pad.
Upholstery Garden fabric.

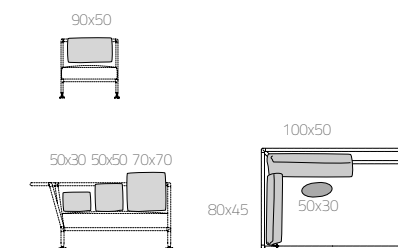



Sedia / Chair

Schienale intrecciato tondino PVC,
cordino acrilico.
Cuscino seduta con imbottitura in dryfeel.
Rivestimento sfoderabile in tessuto Garden.
Copertura in tessuto Tessil.

PVC, acrylic cord woven backrest.
Cushion padding in dryfeel polyurethane.
Removable Garden fabric cover.
Tessil fabric cover.

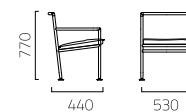

Tavolo rettangolare / Rectangular table

Piano in alluminio verniciato o quarzo a spacco.
Varnished aluminium or "slate looking" quartz stone top.

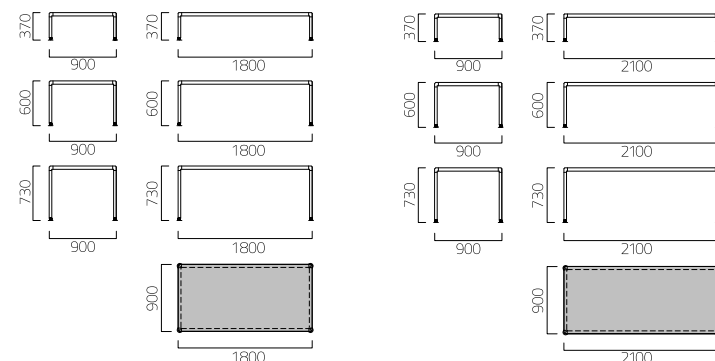

Tavolo quadrato / Square table

Piano in alluminio verniciato o quarzo a spacco.
Varnished aluminium or "slate looking" quartz stone top.
I tavoli Nest possono essere realizzati su misura /
Custom-made Nest tables available on request

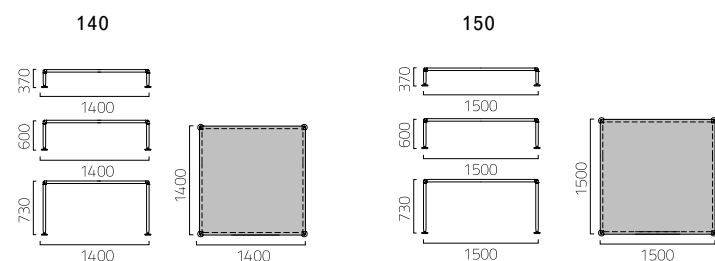

Tavolino rettangolare / Rectangular low table

Piano alluminio verniciato.
Piano trafficstone wave.

Top varnished aluminium.
Top trafficstone wave.

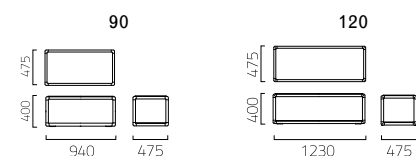

Divano lineare 120 / Linear sofa 120

Cuscino seduta e schienale con imbottitura
in dryfeel, rivestimento sfoderabile in tessuto
outdoor in vari colori.
Copertura in tessuto Tessil.

Seat and back cushion padding in dryfeel
polyurethane, removable outdoor fabric
cover, available in different colours.
Tessil fabric cover.

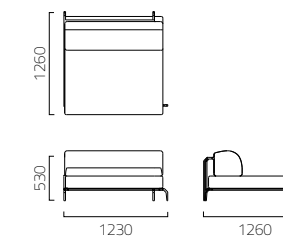

Divano angolare 120/ Corner sofa 120

Cuscino seduta e schienale con imbottitura
in dryfeel, rivestimento sfoderabile in
tessuto
outdoor in vari colori.
Copertura in tessuto Tessil.

Seat and back cushion padding in dryfeel
polyurethane, removable outdoor fabric
cover, available in different colours.
Tessil fabric cover.

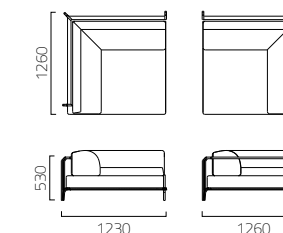

Divano lineare 240/ Linear sofa 240

Cuscino seduta e schienale con imbottitura
in dryfeel, rivestimento sfoderabile in tessuto
outdoor in vari colori.
Copertura in tessuto Tessil.

Seat and back cushion padding in dryfeel
polyurethane, removable outdoor fabric
cover, available in different colours.
Tessil fabric cover.

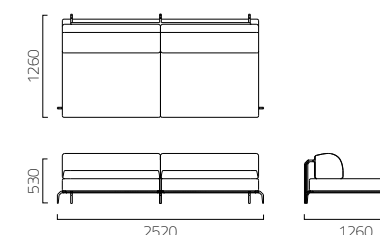

Divano lineare 240 dx-sx / Linear sofa 240 dx-sx

Cuscino seduta e schienale con imbottitura
in dryfeel, rivestimento sfoderabile in tessuto
outdoor in vari colori.
Copertura in tessuto Tessil.

Seat and back cushion padding in dryfeel
polyurethane, removable outdoor fabric
cover, available in different colours.
Tessil fabric cover.

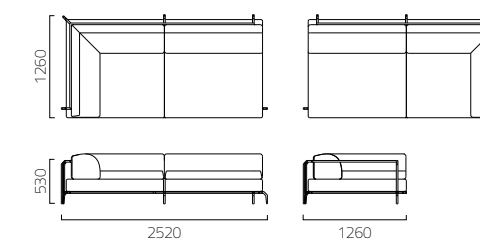



**Divano lineare 240 con braccioli /
Linear sofa 240 with arms**

Cuscino seduta e schienale con imbottitura in dryfeel, rivestimento sfoderabile in tessuto outdoor in vari colori.
Copertura in tessuto Tessil.

Seat and back cushion padding in dryfeel polyurethane, removable outdoor fabric cover, available in different colours.
Tessil fabric cover.

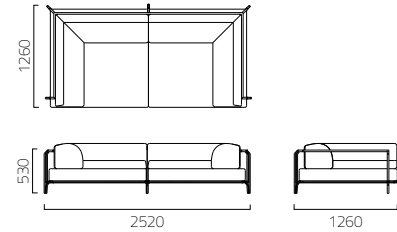

**Divano lineare 120 dx-sx tavolino laterale /
Linear sofa 120 dx-sx side table**

Cuscino seduta e schienale con imbottitura in dryfeel, rivestimento sfoderabile in tessuto outdoor in vari colori.
Tavolo laterale, piano in laminato o teak.
Copertura in tessuto Tessil.

Seat and back cushion padding in dryfeel polyurethane, removable outdoor fabric cover, available in different colours.
Sidetable, top in laminate or teak.
Tessil fabric cover.

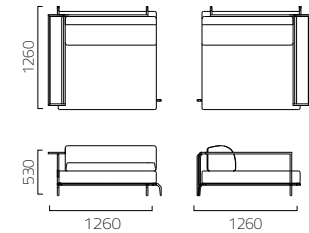

**Divano lineare 240 dx-sx tavolino laterale
Linear sofa 240 dx-sx side table**

Cuscino seduta e schienale con imbottitura in dryfeel, rivestimento sfoderabile in tessuto outdoor in vari colori.
Tavolo laterale, piano in laminato o teak.
Copertura in tessuto Tessil.

Seat and back cushion padding in dryfeel polyurethane, removable outdoor fabric cover, available in different colours.
Sidetable, top in laminate or teak.
Tessil fabric cover.

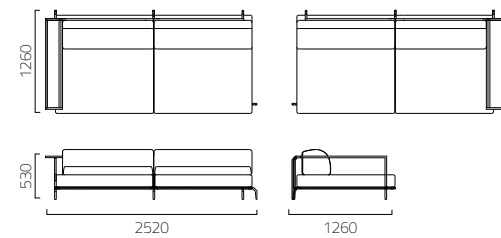

**Divano lineare 240 dx-sx tavolino laterale
Linear sofa 240 dx-sx side table**

Cuscino seduta e schienale con imbottitura in dryfeel, rivestimento sfoderabile in tessuto outdoor in vari colori.
Tavolo laterale, piano in laminato o teak.
Copertura in tessuto Tessil.

Seat and back cushion padding in dryfeel polyurethane, removable outdoor fabric cover, available in different colours.
Sidetable, top in laminate or teak.
Tessil fabric cover.

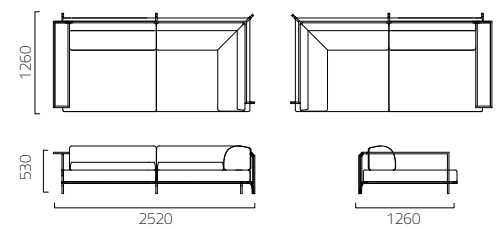

**Divano lineare 240 dx-sx tavolino laterale
Linear sofa 240 dx-sx side table**

Cuscino seduta e schienale con imbottitura in dryfeel, rivestimento sfoderabile in tessuto outdoor in vari colori.
Tavolo laterale, piano in laminato o teak.
Copertura in tessuto Tessil.

Seat and back cushion padding in dryfeel polyurethane, removable outdoor fabric cover, available in different colours.
Sidetable, top in laminate or teak.
Tessil fabric cover.

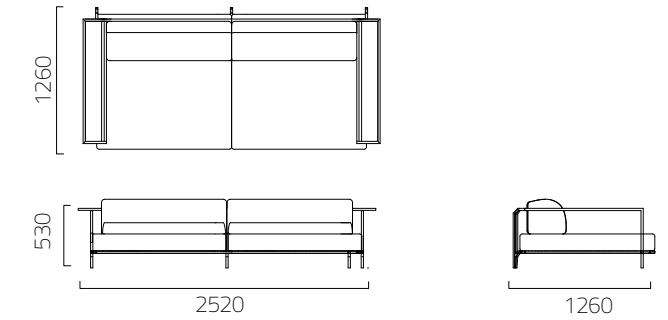

**Cuscino con imbottitura in dryfeel. Rivestimento sfoderabile in tessuto Garden
Dryfeel pad cushion. Cover in Garden fabric**

Cuscino schienale cm 50x30, 50x50, 60x60, 70x70
Cuscino schienale bordato con cordoncino tessile cm 50x30, 50x50, 60x60, 70x70

Back cushion cm 50x30, 50x50, 60x60, 70x70
Textile string-trimmed back cushion cm 50x30, 50x50, 60x60, 70x70

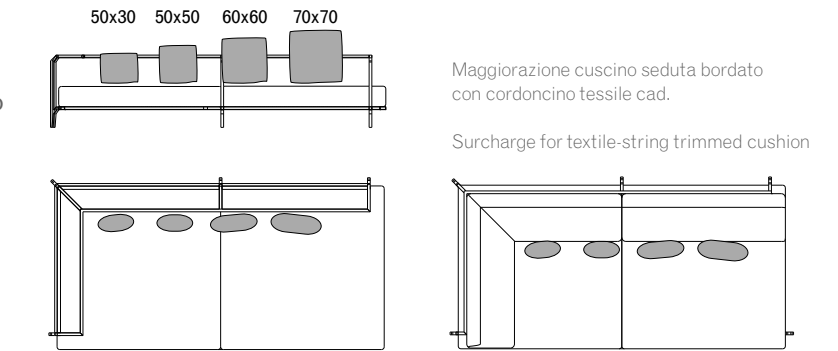

**Tavolo rettangolare
Rectangular table**

Piani tavoli in laminato
Laminated table top

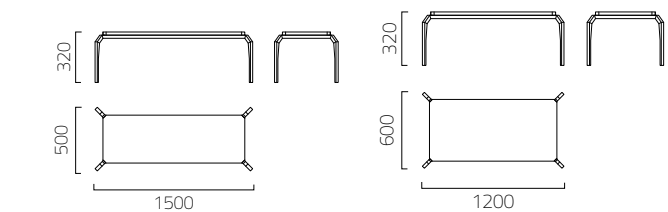

**Tavolo quadrato
Square table**

Piani tavoli in laminato
Laminated table top

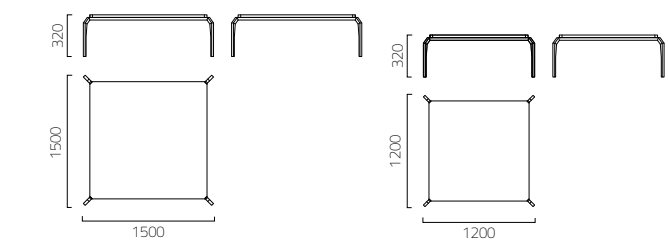

BOOMY

Struttura in acciaio e alluminio verniciato /
Steel and aluminum powder coated frame



Sdraio impilabile / Stackable beach chair

Seduta in tessuto Batyline® o Sun

Seat in Batyline® or Sun fabric

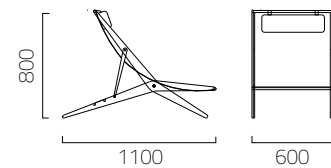

Cuscino poggiatesta / Headrest cushion

Cuscino poggiatesta imbottito in tessuto Batyline® o Sun

Padded headrest cushion in Batyline® or Sun fabric

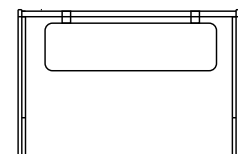

COCOTTE



Poltrona / Armchair

Imbottitura in polistirene rivestito in PVC.
Seduta in tessuto Sea,
sfoderabile per esterno.

Polystyrene padding in PVC cover.
Upholstery Sea fabric for outdoor.

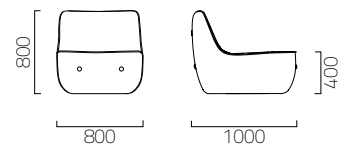

Pouf/ Pouff

Imbottitura in polistirene rivestito in PVC.
Seduta in tessuto Sea,
sfoderabile per esterno.

Polystyrene padding in PVC cover.
Upholstery Sea fabric for outdoor.



JUBEAE

Struttura in acciaio inox satinato o verniciato/
Brushed stainless steel or powder coated steel frame



Sedia senza braccioli/ Chair with arms

Seduta e schienale intrecciati in tondino PVC.
Seduta e schienale intrecciati in cordino acrilico.

PVC woven seat and backrest.
Acrylic cord woven seat and backrest.

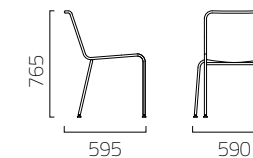

Sedia con braccioli/ Chair without arms

Seduta e schienale intrecciati in tondino PVC.
Seduta e schienale intrecciati in cordino acrilico.

PVC woven seat and backrest.
Acrylic cord woven seat and backrest.

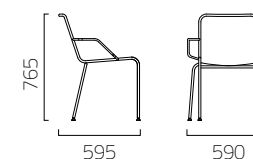

Poltroncina impilabile / Stockable armchair

Seduta e schienale twine.

Twine seat and backrest.



Pouff / Ottoman

Seduta intrecciata in tondino PVC.
Seduta intrecciata in cordino acrilico.
Seduta in tessuto Sun. o Batyline®
Seduta twine.

PVC owoven seat
Acrylic cord owoven seat
Removable Sun or Batyline® fabric seat
Twine seat

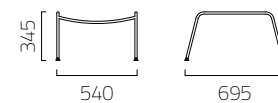

Tavolo quadrato / Square table

Tavolo quadrato
Piano in alluminio verniciato

quare table
Top in varnished aluminum.

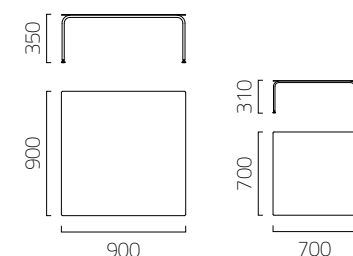

Sedia regista / Director chair

Seduta e schienale in tessuto tecnico
Sun o Batyline®

Seat and back in tecnical fabric
Sun or Batyline®

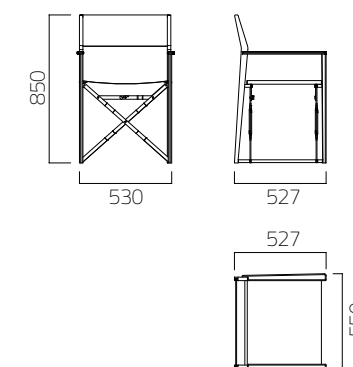

S

**Sedia senza braccioli impilabile a gruppi di 6 /
Stackable chair without arms - up to 6**

Seduta e schienale intrecciati tondino PVC, cordino
acrilico, o in doghe di poliuretano rigido.
Possibilità cuscino seduta in tessuto Tex o Garden.

PVC, acrylic cord woven or stiff polyurethane
slat seat and backrest.
Seat cushion available in Garden or Tex fabric.

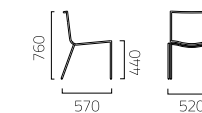

SB

Sedia con braccioli / Chair with arms

Seduta e schienale intrecciati tondino PVC, cordino
acrilico, o in doghe di poliuretano rigido.
Possibilità cuscino seduta in tessuto Tex o Garden.

PVC, acrylic cord woven or stiff polyurethane
slat seat and backrest.
Seat cushion available in Garden or Tex fabric.

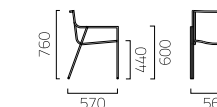

P

Poltrona / Armchair

Seduta e schienale intrecciati tondino
PVC, cordino acrilico o in doghe di poliuretano rigido.
Possibilità cuscino seduta in tessuto Tex o Garden.

PVC, acrylic cord woven or stiff polyurethane slats
seat and backrest. Seat cushion available in Garden
or Tex fabric.

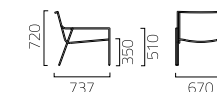

D

Divanetto / Sofa

Seduta e schienale intrecciati tondino PVC o cordino acrilico

PVC or acrylic cord woven seat and backrest.



**PD****Poltrona a dondolo / Rocking armchair**

Seduta e schienale intrecciati tondino PVC o cordino acrilico

PVC or acrylic cord woven seat and backrest.

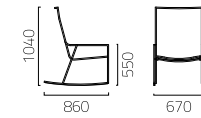
**L****Lettino / Sun lounger**

Seduta e schienale intrecciati tondino PVC o cordino acrilico.

PVC or acrylic cord woven seat and backrest.

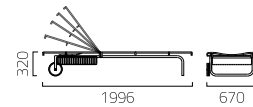
**AM****Amaca / Hammock**

Amaca in rete.

Rope hammock.

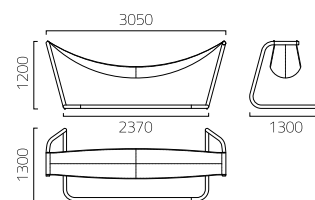
**SGA****Sgabelli impilabili a gruppi di 6 /
Stackable stools - up to 6 items**

Seduta intrecciata tondino PVC o cordino acrilico.

PVC or acrylic cord woven seat.

**Sedia regista / Director chair**

Seduta e schienale in tessuto Leaf o Garden.

Seat and backrest in Leaf or Garden fabric.

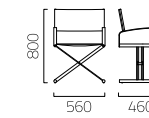
**Sgabello / Stool**

Seduta in tessuto Leaf o Garden.

Seat in Leaf or Garden fabric.

**Chaise longue pieghevole /
Folding chaise longue**

Seduta in tessuto Leaf.

Seat in Leaf fabric.

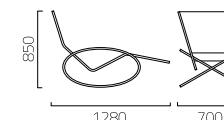

**Sedia / Chair**

Pieghevole e impilabile. Seduta in polistirene.

Folding and stackable. Seat in polystyrene.

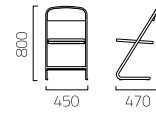
**Tavolo quadrato e rotondo /
Square and round table**

Pieghevole. Piano stratificato.

Folding. Top in high thickness laminate.

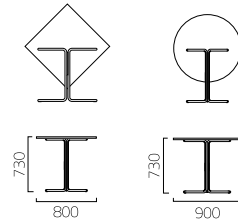
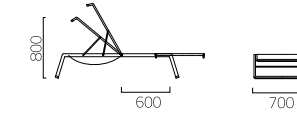
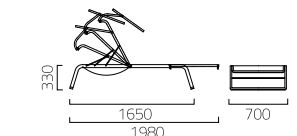
**Lettino impilabile / Stackable sun lounger**Seduta, schienale e poggiatesta in tessuto Sun o Batyline®.
Schienale regolabile.
Poggiatesta allungabile, scorrevole e a scomparsa.Seat and backrest in Sun or Batyline® fabric.
Adjustable backrest.
Extensible sliding footrest.**Lettino impilabile con parasole /
Stackable sun lounger with sun-shade roof**Seduta, schienale e poggiatesta in tessuto Sun o Batyline®.
Schienale regolabile.
Poggiatesta allungabile, scorrevole e a scomparsa.Seat and backrest in Sun or Batyline® fabric.
Adjustable backrest.
Extensible sliding footrest.**Box**Contenitore L3 con tavolino scorrevole
in alluminio.

Container L3 with aluminum powder coated sliding table

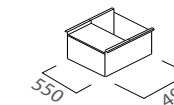
**Ruote /Wheels**

Maggiorazione per lettino con ruote

Surcharge for sunlounger on wheels

TASIA

Struttura in acciaio verniciato/
Powder coated steel frame



**Tavolo rettangolare allungabile /
Rectangular extendable table**

Piano in solido core o in teak

Top in solide core or teak

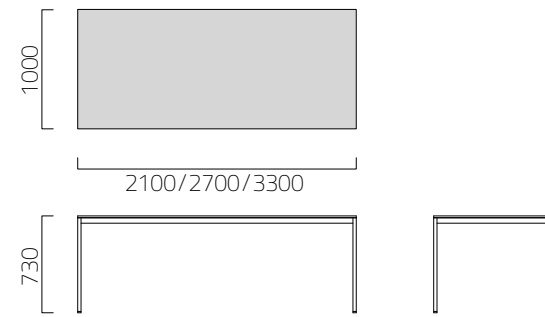

**Estensione tavolo /
Table extendable**

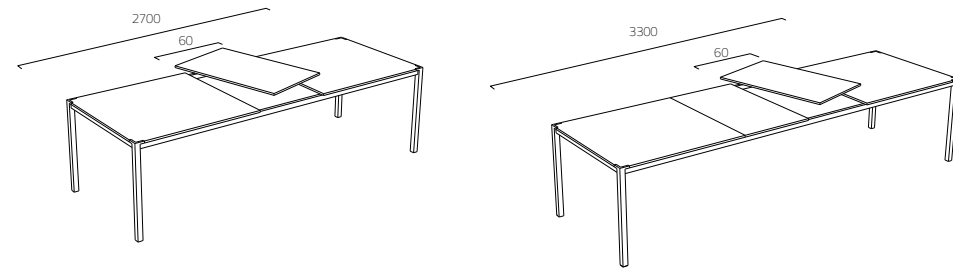

JOINT

Struttura in acciaio inox satinato/
Brushed stainless steel frame



**Tavolo rettangolare /
Rectangular table**

Piano in solido core

Solide core top

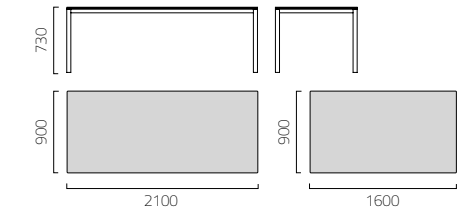

**Tavolo quadrato /
Square table**

Piano in solido core

Solide core top

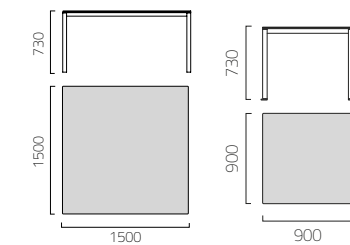

**Gamba di giunzione /
Joint leg**

Gamba di giunzione per unire i tavoli

Joint leg

SHOT

Struttura in acciaio inox satinato/
Brushed stainless steel frame



Tavolo rettangolare / Rectangular table

Piano stratificato, in doghe di poliuretano rigido, o pietra Zimbabwe.

High thickness laminate, stiff polyurethane slat, or black Zimbabwe stone top.

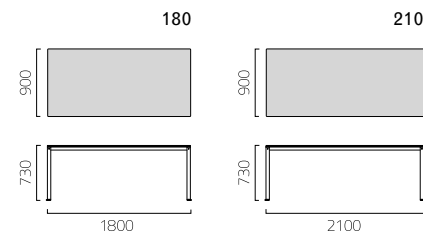

Tavolo quadrato / Square table

Piano stratificato, in doghe di poliuretano rigido, o pietra Zimbabwe.

High thickness laminate, stiff polyurethane slat, or black Zimbabwe stone top.

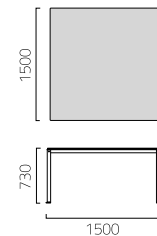

Tavolo quadrato basso / Square low table

Piano stratificato, in doghe di poliuretano rigido, o pietra Zimbabwe.

High thickness laminate, stiff polyurethane slat, or black Zimbabwe stone top.

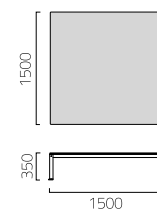

Tavolino quadrato basso / Small square low table

Piano stratificato, in doghe di poliuretano rigido, o pietra Zimbabwe.

High thickness laminate, stiff polyurethane slat, or black Zimbabwe stone top.

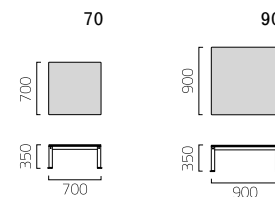

OBQ

Struttura in acciaio inox satinato/
Brushed stainless steel frame



OBQ 3-4

Ombrellone quadrato in tessuto Tex.

Square sunshade in Tex fabric.

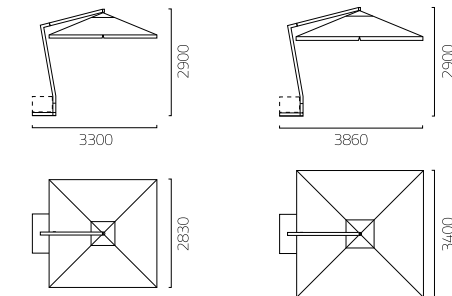

OPQ



OBQ 3-4

Ombrellone quadrato in tessuto Tex..

Square sunshade in Tex fabric.

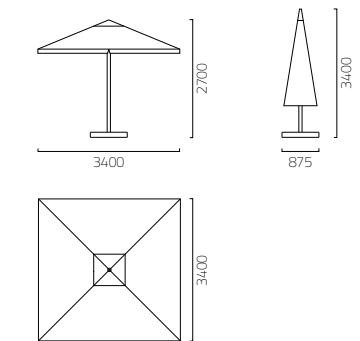

DOCCIA



Doccia / Shower

Doccia dotata di diffusore.

Shower with nebulizer.

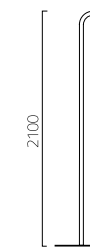

SAVER



Diffusore doccia universale per bottiglie in PET disponibile nei colori azzurro e verde

Universal shower diffuser for PET bottles available in blue or green colours

FIORIERE

Struttura in acciaio inox satinato/
Brushed stainless steel frame



Fioriere / Flower pots

Rivestimento interno in Enkadrain.
Disponibili anche nella versione con ruote.

Equipped inside with an insulating material called Enkadrain.
Available also with carrying wheels.

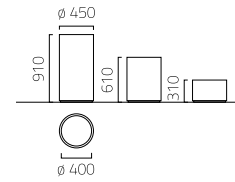

Le fioriere possono essere realizzate su misura.
Custom-made flower pots available on request.

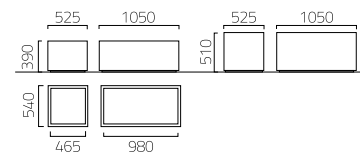

SG1

Struttura in acciaio inox satinato/
Brushed stainless steel frame



TQb

Tavolino quadrato basso / Small square low table

Piano stratificato o in doghe di poliuretano rigido.

High thickness laminate or stiff polyurethane slat top.

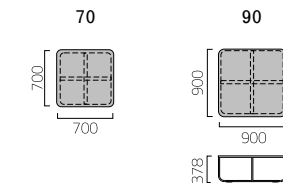

TOb

Tavolo rotondo basso / Small round low table

Piano stratificato o in doghe di poliuretano rigido.

High thickness laminate or stiff polyurethane slat top.

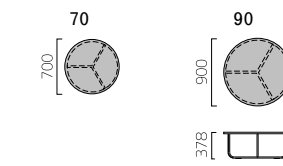

TAVOLO RIO

Struttura in acciaio verniciato epossidico bianco
White powder epoxy coated steel frame



Tavolo Rio / Rio table

Piano metacrilato o stratificato.

Methacrylate or in high thickness laminate top.

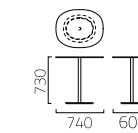

TAVOLO RAB

Struttura in acciaio inox satinato / Struttura in acciaio verniciato epossidico
Brushed stainless steel frame. Powder epoxy coated steel frame



Tavolo Rab / Rab table

Piano metacrilato o stratificato.

Methacrylate or in high thickness laminate top.

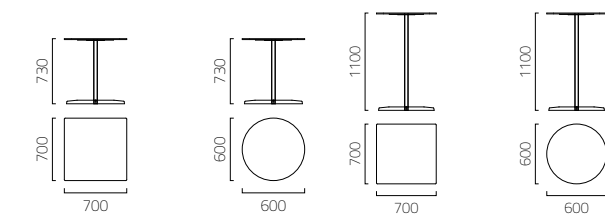



FINITURE / FINISHES

Acciaio satinato
Brushed stainless steel



Tondino PVC rinforzato nylon
Reinforce PVC nylon cord



Tessuto TEX
TEX fabric



Laminato stratificato
high thickness laminate



Poliuretano rigido
Stiff polyurethane



Cordino acrilico 3 mm
Acrylic cord 3 mm



Cordino acrilico 6 mm
Acrylic cord 6 mm



Finitura Twine
Twine finishes

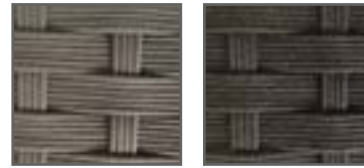

Tessuto Batyline® Eden
Eden Batyline® fabric



EDEN 50552 EDEN 50556 EDEN 50734

Tessuto Batyline® Iso
Iso Batyline® fabric

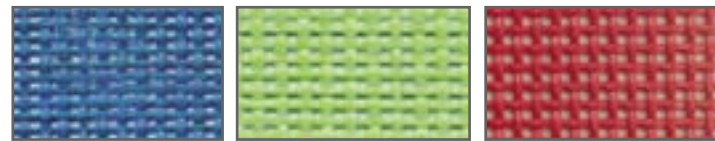

ISO 5364 ISO 5063 ISO 5011

Tessuto Sun
Sun fabric



SUN 1 SUN 3 SUN 4



I colori illustrati in questo catalogo possono variare, perché si tratta di una stampa su carta. CORO si riserva il diritto di modificare i prodotti senza preavviso con il motivo di migliorarli tecnicamente.

Paint fabrics and finishes colors in this catalogue may vary a little because of the printing. CORO reserves the right to modify products without notice in order to make technical improvements.

Ramak Fazel	lifestyle photo
Max Rommel	lifestyle photo
Federico Cedrone	lifestyle + still life photo
Armando Bertacchi	still life photo
Damiano Lorenzon	still life photo
Leonardo Pelucchi	still life photo
Henny van Belkom	lifestyle photo
Dario Fusaro	lifestyle photo
Max Zambelli	lifestyle photo
Elio Nasuelli	text
Daniele Oberrauch	photo assistant
Stefano Baccocchi	graphic+3d visualizer
Rita Mazzoni	graphic design
Leva S.r.l.	print

Un particolare ringraziamento/ Special thanks to

Monique Donders
Sig.ri Grassi
Arch. Giovanni Guscelli
Flavio Ferrari
Caroline Aldous
Ignazio Messina & C. Spa – Genova
Nikken Total Plan Co. LTD.
Kayukaya Project
Ferretti Yacht
A-Nathstudio project
Filippo Marsigli
Famiglia Hug
Arch. Gavino Falchi

CORO
Viale della Repubblica, 59
20851 Lissone - MB

Tel +39 039 27 26 260
Fax +39 039 27 27 409
info@coroitalia.it
www.coroitalia.it

CORO si riserva la facoltà di apportare ai prodotti tutte le modifiche, migliorie tecniche e annullamenti di articoli di fine serie che siano ritenuti opportuni, in qualsiasi momento senza alcun preavviso.

CORO reserves the right to alter, improve and discontinue items as and when considered necessary or opportune, at any time and without notice.

Stampato in Italia Maggio 2018

